

Article number: 201580M510PL

Description: E+G Screw GN 1580-M5-10-PL-H
Hygienic design

Measures

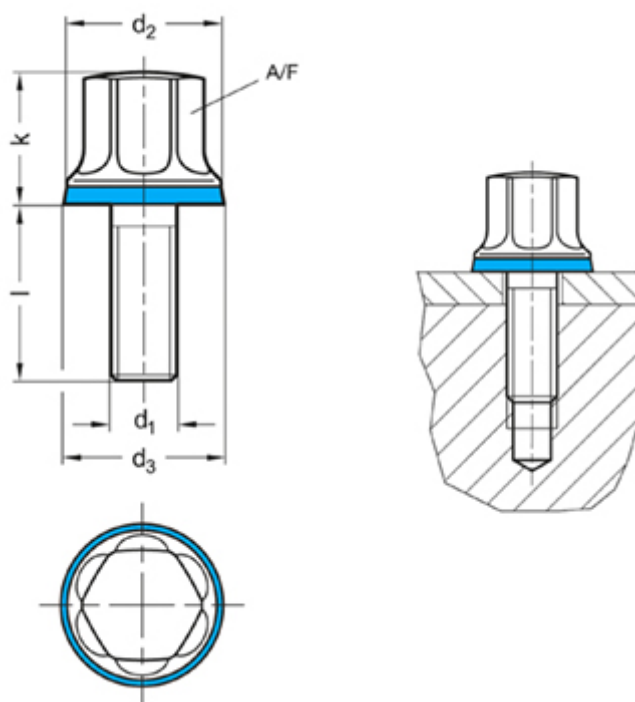

d1	= M 5
d2	= 12
d3	= 12.8
k	= 10
L	= 10
t min	= -
Weight in (g)	= 6